

VG.MB040X80 oval bellows suction cup with non-slip cleats in NBR

- Ideal for handling oiled sheet metal in stamping processes
- Handling of flat glass and shaped glass
- Special cleats that increase friction on lubricated surfaces
- Ideal for applications where contamination of the material must be avoided (PWIS)
- Bellows suction cups in NBR, 60 Shore, with vulcanised fitting
- Internal supports help to prevent deformation of thin sheet metal
- Suitable for handling flat and slightly curved surfaces thanks to the wide lip

NEW



Application example



Technical data

Material	Lifting force [N] perpendicular to the surface, at various vacuum levels			Lifting force [N] parallel to the surface, at various vacuum levels			Volume [cm ³]	Min curve radius [mm]	Max vert. movement [mm]	Suction cup weight [g]
	-20 kPa	-60 kPa	-90 kPa	-20 kPa	-60 kPa	-90 kPa				
NBR 60	58	120	157	47	113	147	21.8	25	9	29

Technical features

Material	Colour	Hardness	Temperature range
NBR 60	Black	60 Shore	-30 ÷ +100 °C

Identification codes			
Drawing	Alphanumeric code	Suction cups with fitting	Ordering code
A	VG.MBO40X80N.60.G14M	VG.MBO40X80 suction cup, NBR, 60 Shore, G1/4" male	3100069
B	VG.MBO40X80N.60.G14F	VG.MBO40X80 suction cup, NBR, 60 Shore, G1/4" female	3100070
C	VG.MBO40X80N.60.G38F	VG.MBO40X80 suction cup, NBR, 60 Shore, G3/8" female	3100072

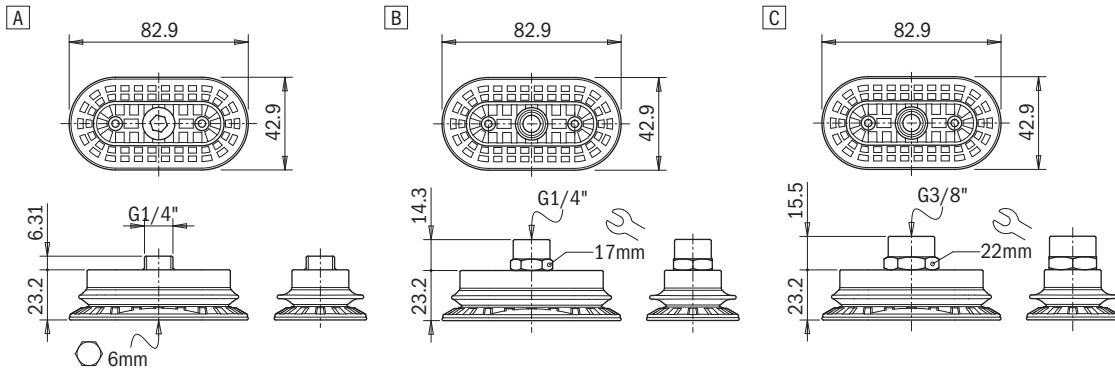

Identification codes			
Drawing	Alphanumeric code	Suction cups	Order code
A	VG.MBO40X80N.60	VG.MBO40X80 suction cup, NBR, 60 Shore	3100073

